



# PJU4NA70 / PJD4NA70 / PJP4NA70 / PJF4NA70

## 700V N-Channel MOSFET

**Voltage**

**700 V**

**Current**

**4 A**

### Features

- $R_{DS(ON)}$ ,  $V_{GS}@10V, I_D@2A < 2.8\Omega$
- High switching speed
- Improved dv/dt capability
- Low Gate Charge
- Low reverse transfer capacitance
- Lead free in compliance with EU RoHS 2011/65/EU directive.
- Green molding compound as per IEC61249 Std.
- (Halogen Free)

### Mechanical Data

- Case: TO-251AA, TO-252AA, TO-220AB, ITO-220AB-F Package
- Terminals : Solderable per MIL-STD-750, Method 2026
- TO-251AA Approx. Weight : 0.0104 ounces, 0.297grams
- TO-252AA Approx. Weight : 0.0104 ounces, 0.297grams
- TO-220AB Approx. Weight : 0.067 ounces, 1.89 grams
- ITO-220AB-F Approx. Weight : 0.068 ounces, 2 grams

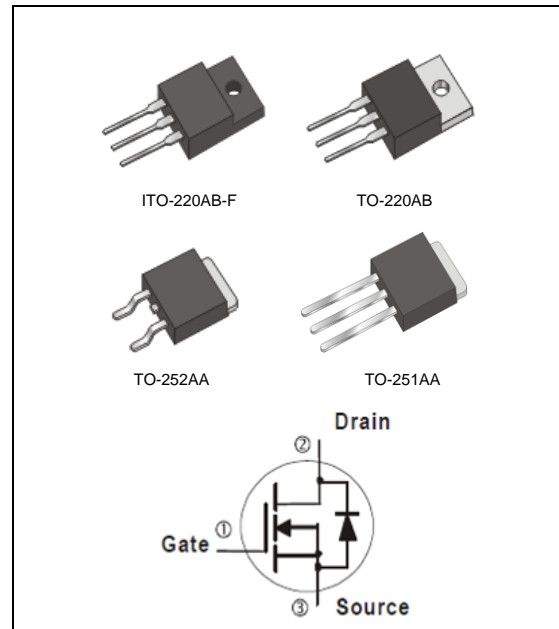

### Maximum Ratings and Thermal Characteristics ( $T_A=25^\circ\text{C}$ unless otherwise noted)

PARAMETER		SYMBOL	TO-251AA	TO-220AB	ITO-220AB-F	TO-252AA	UNITS
Drain-Source Voltage		$V_{DS}$	700				V
Gate-Source Voltage		$V_{GS}$	$\pm 30$				V
Continuous Drain Current		$I_D$	4				A
Pulsed Drain Current		$I_{DM}$	16				A
Single Pulse Avalanche Energy <sup>(Note 1)</sup>		$E_{AS}$	242				mJ
Power Dissipation	$T_C=25^\circ\text{C}$	$P_D$	77	100	33	77	W
	Derate above $25^\circ\text{C}$		0.62	0.8	0.26	0.62	W/ $^\circ\text{C}$
Operating Junction and Storage Temperature Range		$T_J, T_{STG}$	-55~150				$^\circ\text{C}$
Typical Thermal resistance							
- Junction to Case		$R_{\theta JC}$	1.62	1.25	3.79	1.62	$^\circ\text{C}/\text{W}$
- Junction to Ambient		$R_{\theta JA}$	110	62.5	120	110	

- Limited only By Maximum Junction Temperature



# PJU4NA70 / PJD4NA70 / PJP4NA70 / PJF4NA70

## Electrical Characteristics ( $T_A=25^\circ\text{C}$ unless otherwise noted)

PARAMETER	SYMBOL	TEST CONDITION	MIN.	TYP.	MAX.	UNITS
<b>Static</b>						
Drain-Source Breakdown Voltage	$BV_{DSS}$	$V_{GS}=0V, I_D=250\mu A$	700	-	-	V
Gate Threshold Voltage	$V_{GS(th)}$	$V_{DS}=V_{GS}, I_D=250\mu A$	2	-	4	V
Drain-Source On-State Resistance	$R_{DS(on)}$	$V_{GS}=10V, I_D=2A$	-	2.5	2.8	$\Omega$
Zero Gate Voltage Drain Current	$I_{DSS}$	$V_{DS}=700V, V_{GS}=0V$	-	0.03	1.0	$\mu A$
Gate-Source Leakage Current	$I_{GSS}$	$V_{GS}=\pm 30V, V_{DS}=0V$	-	$\pm 10$	$\pm 100$	nA
Diode Forward Voltage	$V_{SD}$	$I_S=4A, V_{GS}=0V$	-	-	1.4	V
<b>Dynamic</b> (Note 4)						
Total Gate Charge	$Q_g$	$V_{DS}=560V, I_D=4A,$ $V_{GS}=10V$ (Note 2,3)	-	10.5	-	nC
Gate-Source Charge	$Q_{gs}$		-	3.2	-	
Gate-Drain Charge	$Q_{gd}$		-	4	-	
Input Capacitance	$C_{iss}$	$V_{DS}=25V, V_{GS}=0V,$ $f=1.0\text{MHz}$	-	514	-	pF
Output Capacitance	$C_{oss}$		-	76	-	
Reverse Transfer Capacitance	$C_{rss}$		-	2	-	
Turn-On Delay Time	$t_{d(on)}$	$V_{DD}=350V, I_D=4A,$ $R_G=25\Omega$ (Note 2,3)	-	16	-	ns
Turn-On Rise Time	$t_r$		-	35	-	
Turn-Off Delay Time	$t_{d(off)}$		-	25	-	
Turn-Off Fall Time	$t_f$		-	23	-	
<b>Drain-Source Diode</b>						
Maximum Continuous Drain-Source Diode Forward Current	$I_S$	---	-	-	4	A
Maximum Pulsed Drain-Source Diode Forward Current	$I_{SM}$	---	-	-	16	A
Reverse Recovery Time	$t_{rr}$	$V_{GS}=0V, I_S=4A$	-	470	-	ns
Reverse Recovery Charge	$Q_{rr}$	$di_F/dt=100A/\mu s$ (Note 2)	-	2.2	-	$\mu C$

**NOTES :**

1.  $L=30\text{mH}, I_{AS}=3.9A, V_{DD}=50V, R_G=25\text{ohm}$ , Starting  $T_J=25^\circ\text{C}$
2. Pulse width  $\leq 300\mu s$ , Duty cycle  $\leq 2\%$
3. Essentially independent of operating temperature typical characteristics.
4. Guaranteed by design, not subject to production testing



# PJU4NA70 / PJD4NA70 / PJP4NA70 / PJF4NA70

## TYPICAL CHARACTERISTIC CURVES

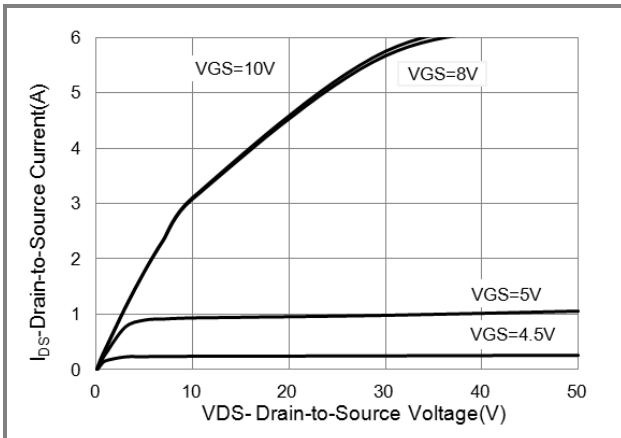

Fig.1 Output Characteristics

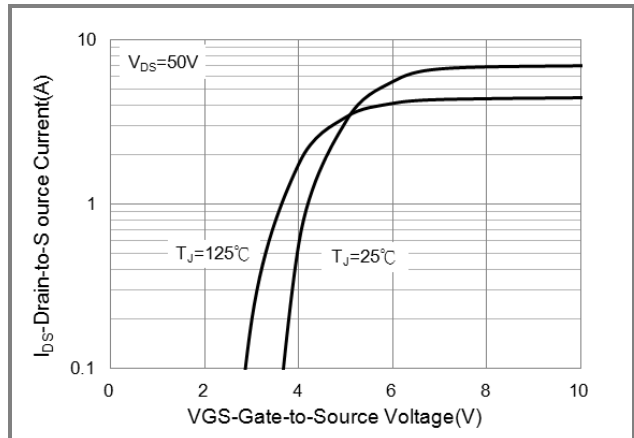

Fig.2 Transfer Characteristics

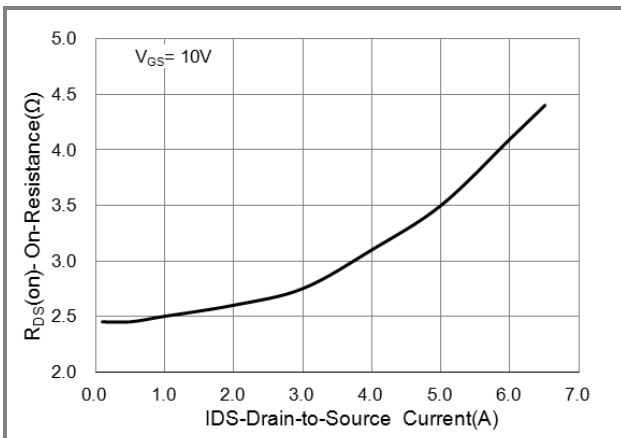

Fig.3 On-Resistance vs. Drain Current

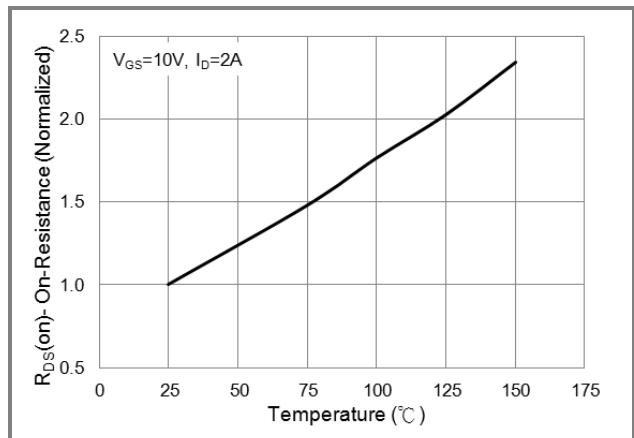

Fig.4 On-Resistance vs. Junction Temperature

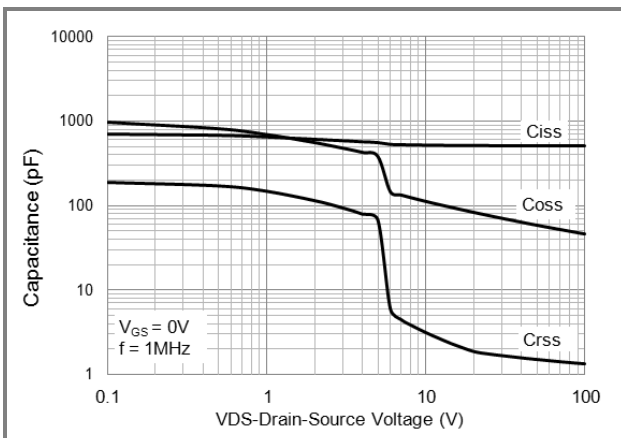

Fig.5 Capacitance vs. Drain-Source Voltage

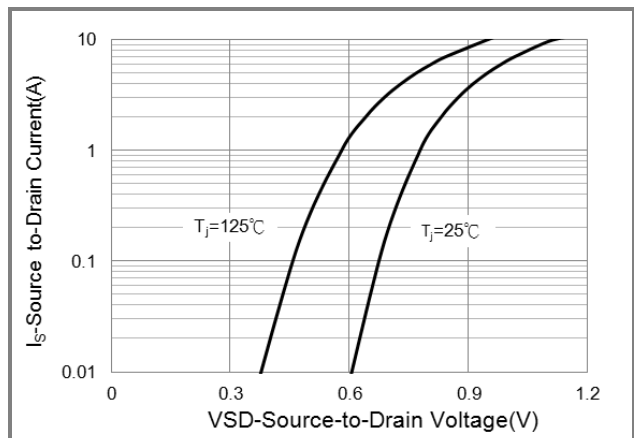

Fig.6 Source-Drain Diode Forward Voltage



# PJU4NA70 / PJD4NA70 / PJP4NA70 / PJF4NA70

## TYPICAL CHARACTERISTIC CURVES

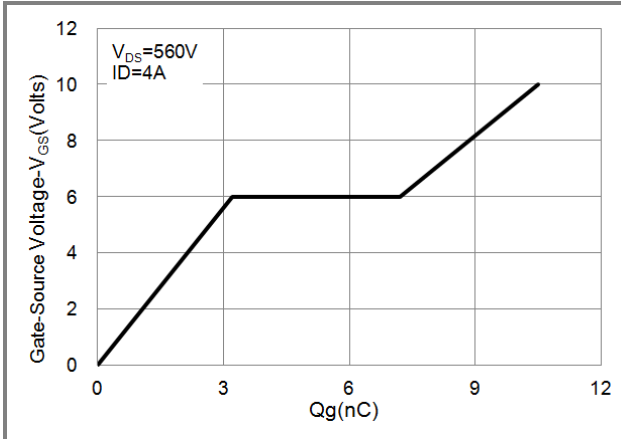

Fig.7 Gate Charge

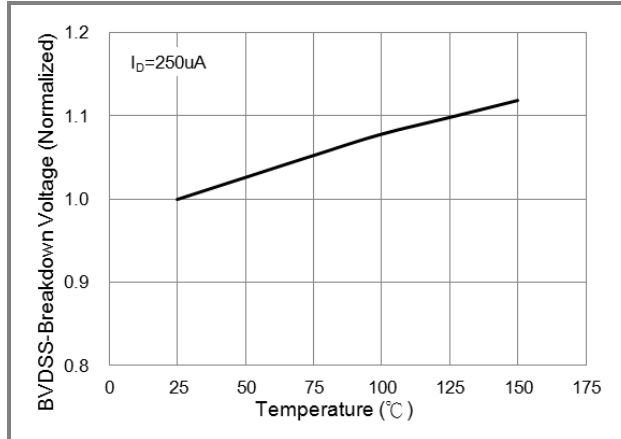

Fig.8  $BV_{DSS}$  vs. Junction Temperature

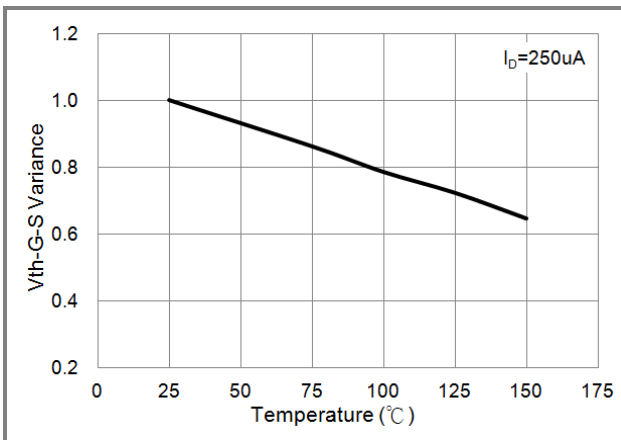

Fig.9 Threshold Voltage Variation with Temperature

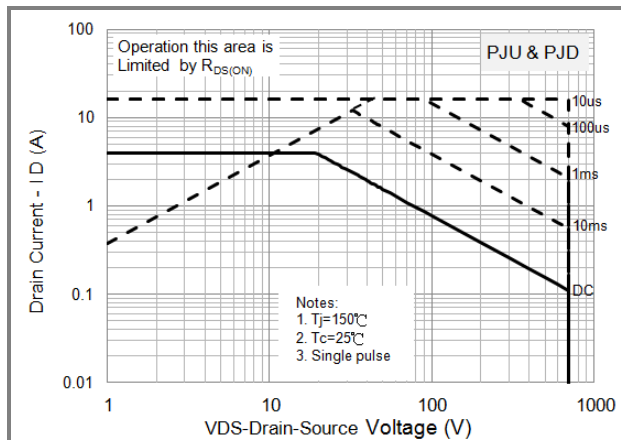

Fig.10 Maximum Safe Operating Area

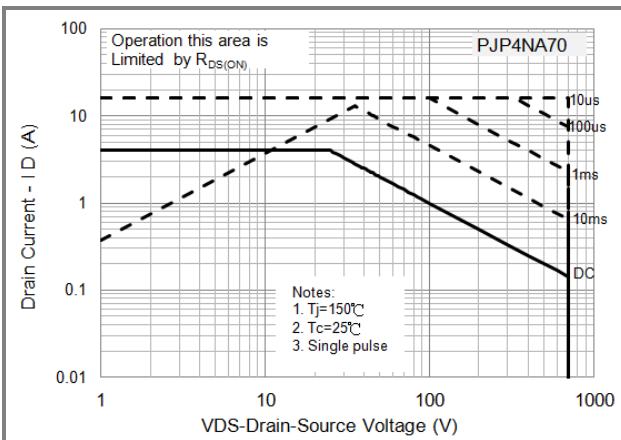

Fig.11 Maximum Safe Operating Area

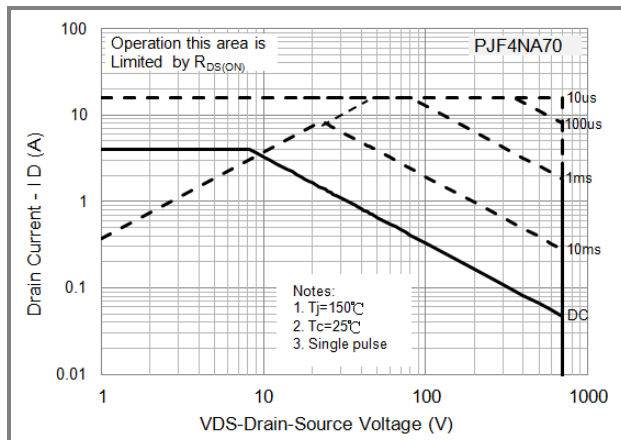

Fig.12 Maximum Safe Operating Area



# PJU4NA70 / PJD4NA70 / PJP4NA70 / PJF4NA70

## TYPICAL CHARACTERISTIC CURVES

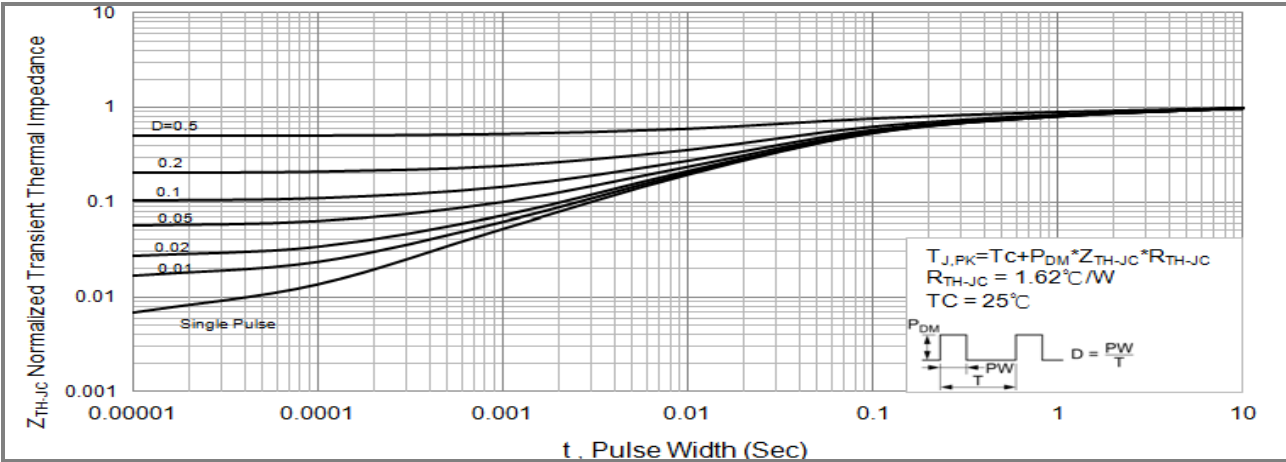

Fig.13 PJU/PJD Normalized Transient Thermal Impedance vs. Pulse Width

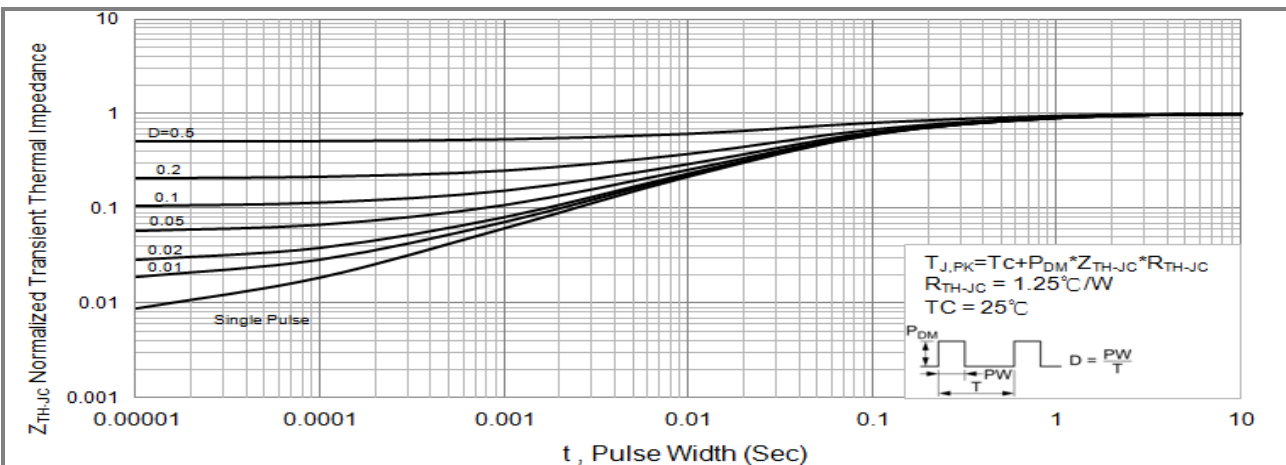

Fig.14 PJP4NA70 Normalized Transient Thermal Impedance vs. Pulse Width

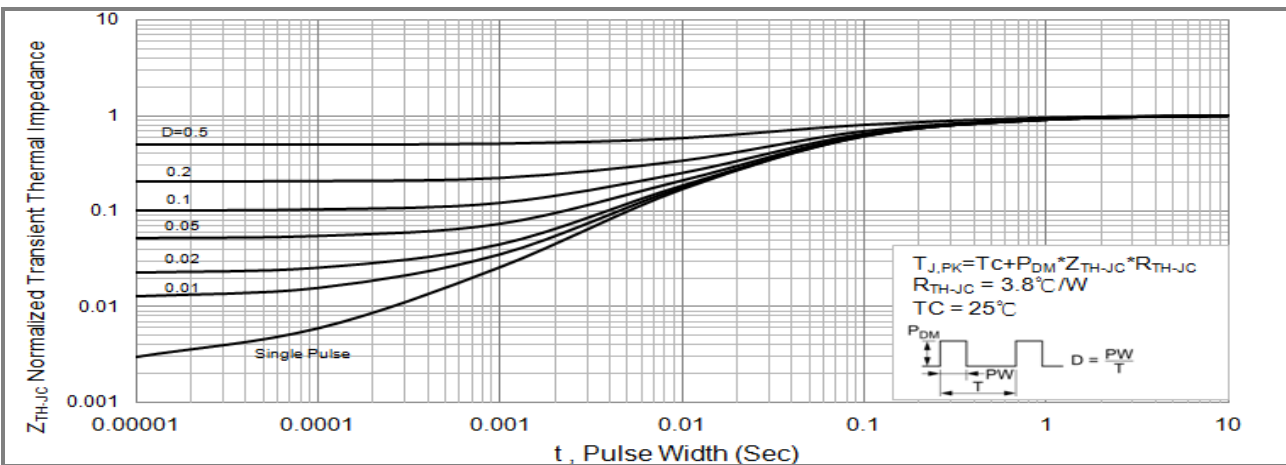
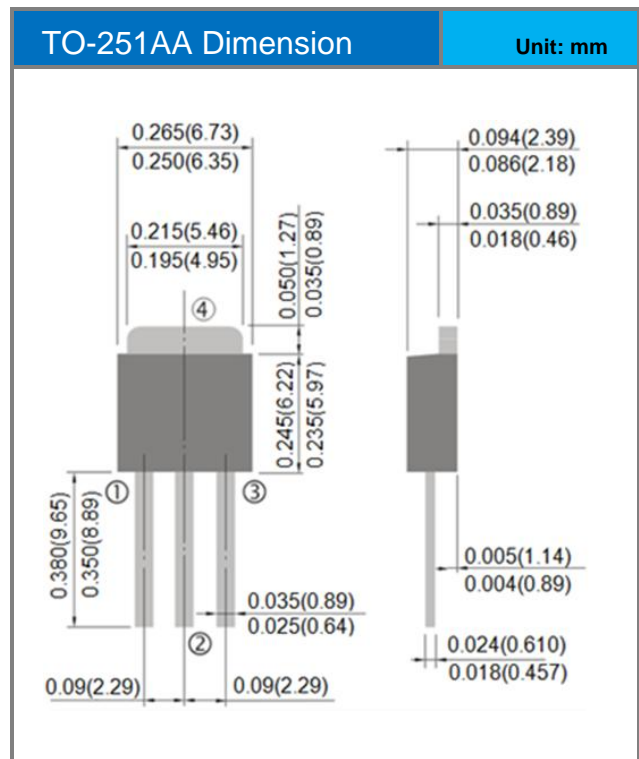
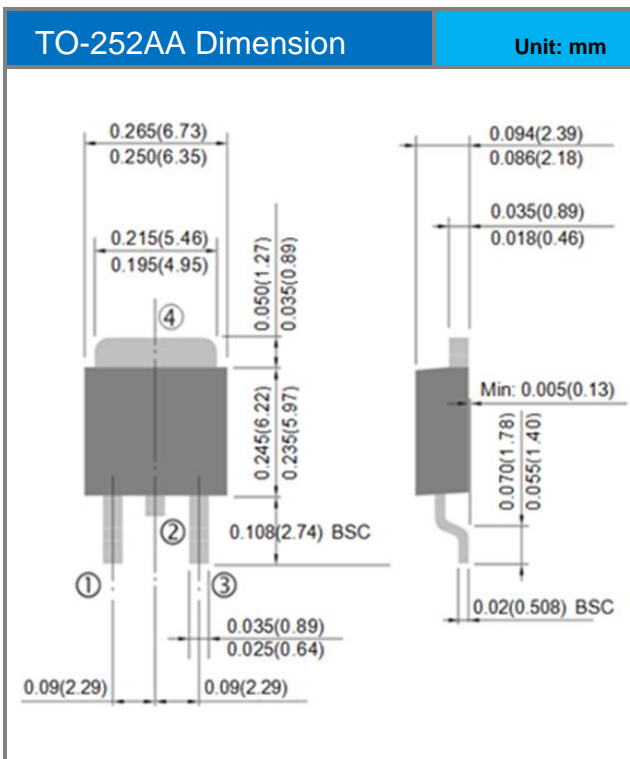
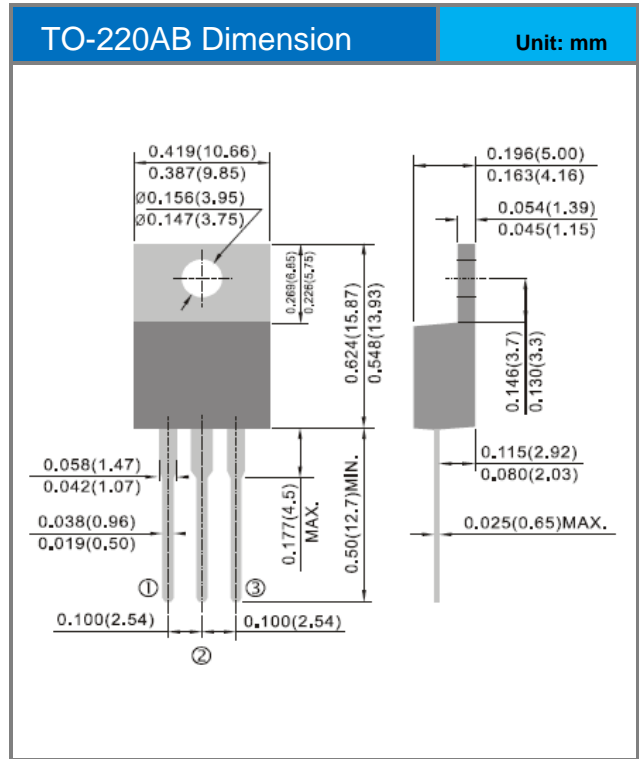
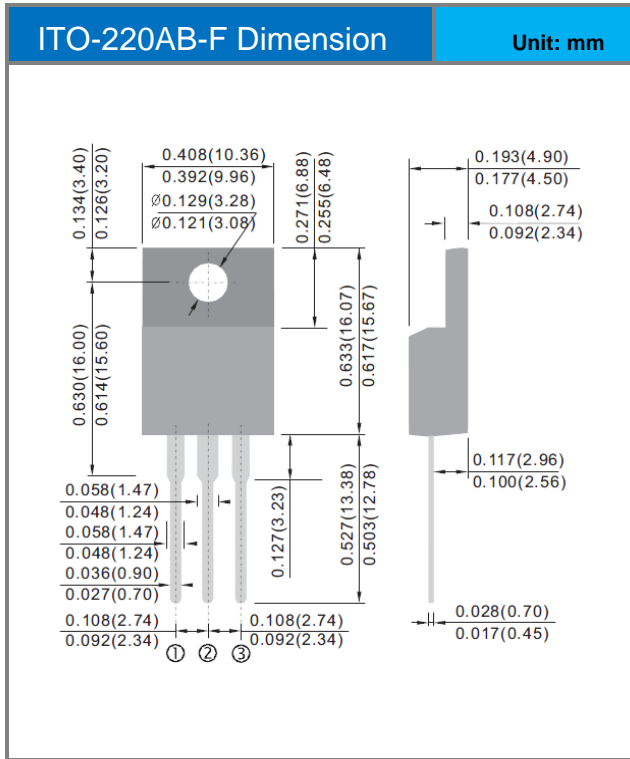

Fig.15 PJF4NA70 Normalized Transient Thermal Impedance vs. Pulse Width



# PJU4NA70 / PJD4NA70 / PJP4NA70 / PJF4NA70

## Packaging Information





## PJU4NA70 / PJD4NA70 / PJP4NA70 / PJF4NA70

### PART NO PACKING CODE VERSION

Part No Packing Code	Package Type	Packing type	Marking	Version
PJU4NA70_T0_00001	TO-251AA	80pcs / Tube	U4NA70	Halogen free
PJD4NA70_L2_00001	TO-252AA	3,000pcs / 13" reel	D4NA70	Halogen free
PJP4NA70_T0_00001	TO-220AB	50pcs / Tube	P4NA70	Halogen free
PJF4NA70_T0_00001	ITO-220AB-F	50pcs / Tube	F4NA70	Halogen free



## **PJU4NA70 / PJD4NA70 / PJP4NA70 / PJF4NA70**

### **Disclaimer**

- Reproducing and modifying information of the document is prohibited without permission from Panjit International Inc..
- Panjit International Inc. reserves the rights to make changes of the content herein the document anytime without notification. Please refer to our website for the latest document.
- Panjit International Inc. disclaims any and all liability arising out of the application or use of any product including damages incidentally and consequentially occurred.
- Panjit International Inc. does not assume any and all implied warranties, including warranties of fitness for particular purpose, non-infringement and merchantability.
- Applications shown on the herein document are examples of standard use and operation. Customers are responsible in comprehending the suitable use in particular applications. Panjit International Inc. makes no representation or warranty that such applications will be suitable for the specified use without further testing or modification.
- The products shown herein are not designed and authorized for equipments requiring high level of reliability or relating to human life and for any applications concerning life-saving or life-sustaining, such as medical instruments, transportation equipment, aerospace machinery et cetera. Customers using or selling these products for use in such applications do so at their own risk and agree to fully indemnify Panjit International Inc. for any damages resulting from such improper use or sale.
- Since Panjit uses lot number as the tracking base, please provide the lot number for tracking when complaining.