



PJS6415

20V P-Channel Enhancement Mode MOSFET

Voltage **-20 V** **Current** **-5.2A**

Features

- $R_{DS(ON)}$, $V_{GS}@-4.5V$, $I_D@-5.2A < 56m\Omega$
- $R_{DS(ON)}$, $V_{GS}@-2.5V$, $I_D@-3.6A < 70m\Omega$
- $R_{DS(ON)}$, $V_{GS}@-1.8V$, $I_D@-1.9A < 94m\Omega$
- Advanced Trench Process Technology
- Specially Designed for Switch Load, PWM Application, etc
- Lead free in compliance with EU RoHS 2011/65/EU directive.
- Green molding compound as per IEC61249 Std. (Halogen Free)

Mechanical Data

- Case: SOT-23 6L Package
- Terminals: Solderable per MIL-STD-750, Method 2026
- Approx. Weight: 0.0005 ounces, 0.014 grams
- Marking: S15

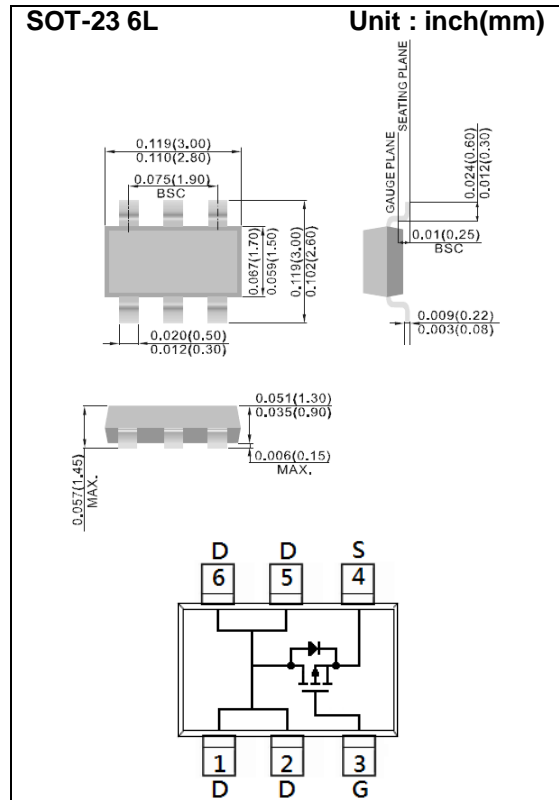

Maximum Ratings and Thermal Characteristics ($T_A=25^\circ C$ unless otherwise noted)

PARAMETER		SYMBOL	LIMIT	UNITS
Drain-Source Voltage		V_{DS}	-20	V
Gate-Source Voltage		V_{GS}	± 12	V
Continuous Drain Current		I_D	-5.2	A
Pulsed Drain Current		I_{DM}	-20.8	A
Power Dissipation	$T_a=25^\circ C$	P_D	2	W
	Derate above $25^\circ C$		16	mW/ $^\circ C$
Operating Junction and Storage Temperature Range		T_J, T_{STG}	-55~150	$^\circ C$
Typical Thermal resistance		$R_{\theta JA}$	62.5	$^\circ C/W$
- Junction to Ambient ^(Note 3)				



PJS6415

Electrical Characteristics ($T_A=25^\circ\text{C}$ unless otherwise noted)

PARAMETER	SYMBOL	TEST CONDITION	MIN.	TYP.	MAX.	UNITS
Static						
Drain-Source Breakdown Voltage	BV_{DSS}	$V_{GS}=0V, I_D=-250\mu A$	-20	-	-	V
Gate Threshold Voltage	$V_{GS(th)}$	$V_{DS}=V_{GS}, I_D=-250\mu A$	-0.4	-0.63	-1.2	V
Drain-Source On-State Resistance	$R_{DS(on)}$	$V_{GS}=-4.5V, I_D=-5.2A$	-	49	56	m Ω
		$V_{GS}=-2.5V, I_D=-3.6A$	-	58	70	
		$V_{GS}=-1.8V, I_D=-1.9A$	-	73	94	
Zero Gate Voltage Drain Current	I_{DSS}	$V_{DS}=-20V, V_{GS}=0V$	-	-0.01	-1	μA
Gate-Source Leakage Current	I_{GSS}	$V_{GS}=\pm 12V, V_{DS}=0V$	-	± 10	± 100	nA
Dynamic						
Total Gate Charge	Q_g	$V_{DS}=-10V, I_D=-5.2A,$ $V_{GS}=-4.5V$ (Note 1,2)	-	18	-	nC
Gate-Source Charge	Q_{gs}		-	2.2	-	
Gate-Drain Charge	Q_{gd}		-	7.5	-	
Input Capacitance	C_{iss}	$V_{DS}=-10V, V_{GS}=0V,$ $f=1.0\text{MHz}$	-	765	-	pF
Output Capacitance	C_{oss}		-	75	-	
Reverse Transfer Capacitance	C_{rss}		-	58	-	
Switching						
Turn-On Delay Time	$t_{d(on)}$	$V_{DD}=-10V, I_D=-5.2A,$ $V_{GS}=-4.5V,$ $R_G=6\Omega$ (Note 1,2)	-	4.8	-	ns
Turn-On Rise Time	t_r		-	63	-	
Turn-Off Delay Time	$t_{d(off)}$		-	72	-	
Turn-Off Fall Time	t_f		-	140	-	
Drain-Source Diode						
Maximum Continuous Drain-Source Diode Forward Current	I_S	---	-	-	-2.0	A
Diode Forward Voltage	V_{SD}	$I_S=-1.0A, V_{GS}=0V$	-	-0.74	-1.2	V

NOTES :

1. Pulse width $\leq 300\mu s$, Duty cycle $\leq 2\%$
2. Essentially independent of operating temperature typical characteristics.
3. $R_{\theta JA}$ is the sum of the junction-to-case and case-to-ambient thermal resistance where the case thermal reference is defined as the solder mounting surface of the drain pins mounted on a 1 inch FR-4 with 2oz. square pad of copper
4. The maximum current rating is package limited



PJS6415

TYPICAL CHARACTERISTIC CURVES

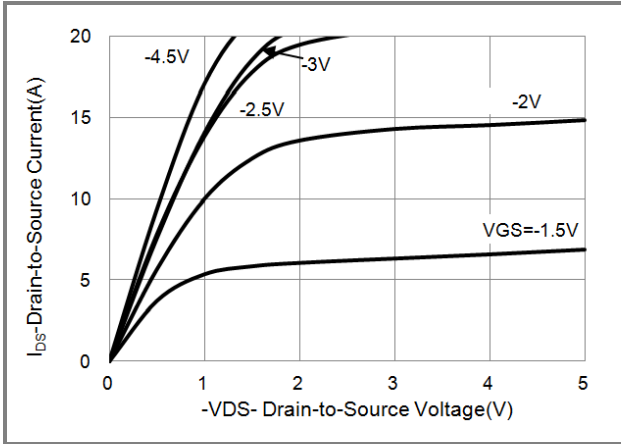

Fig.1 On-Region Characteristics

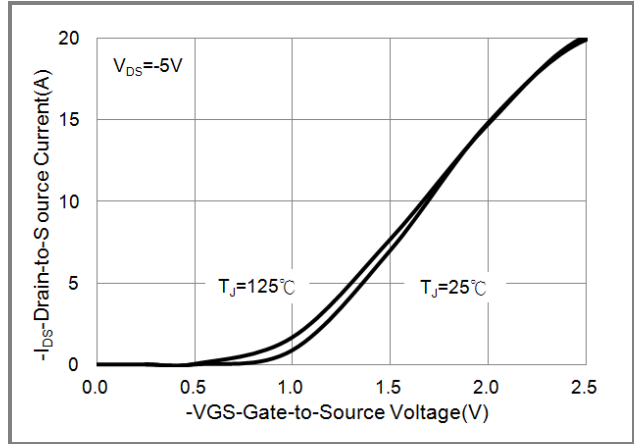

Fig.2 Transfer Characteristics

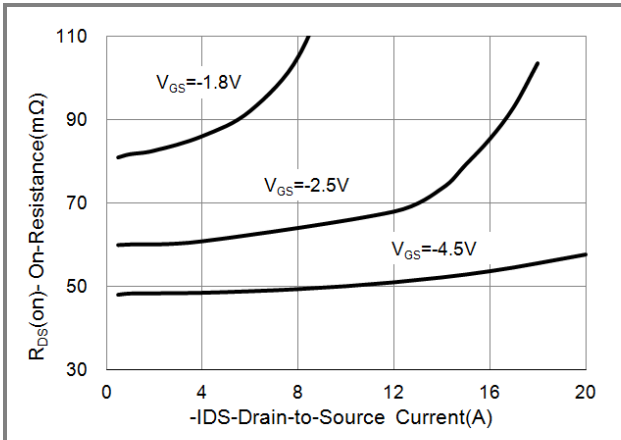

Fig.3 On-Resistance vs. Drain Current

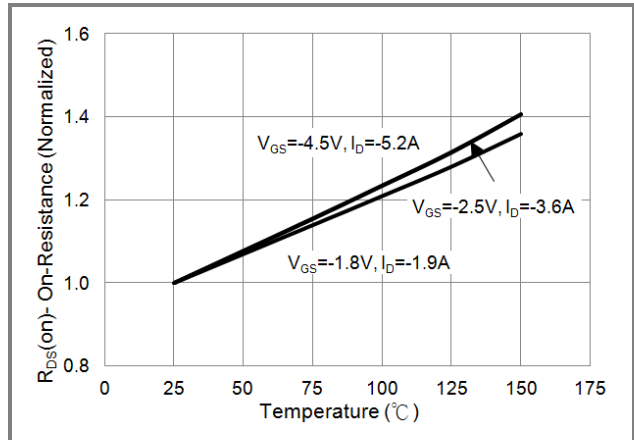

Fig.4 On-Resistance vs. Junction temperature

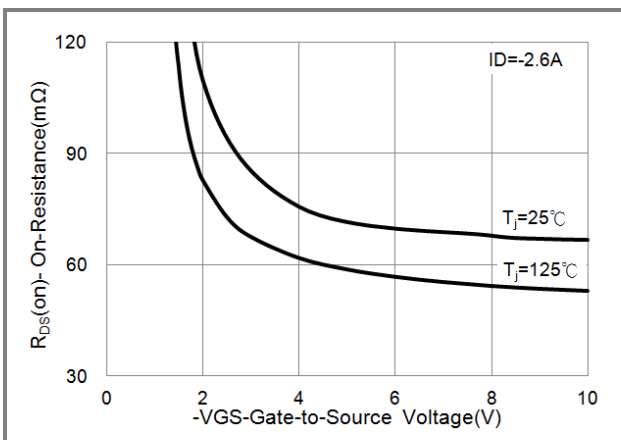

Fig.5 On-Resistance Variation with VGS.

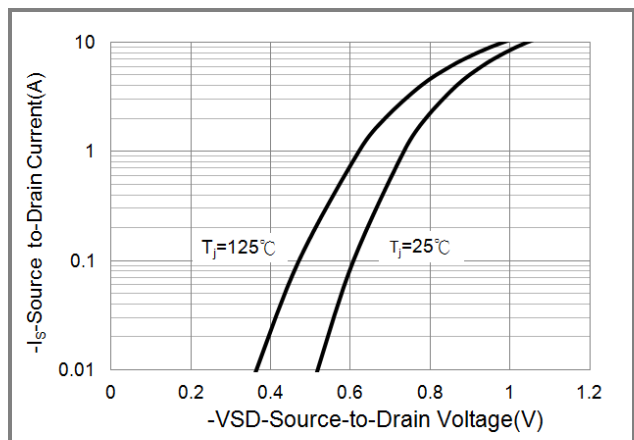

Fig.6 Body Diode Characteristics



PJS6415

TYPICAL CHARACTERISTIC CURVES

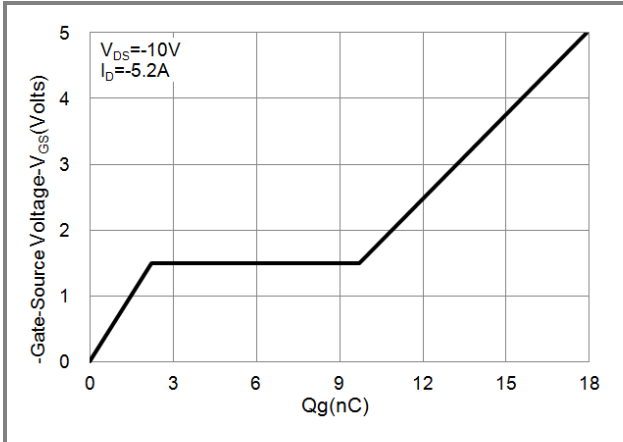

Fig.7 Gate-Charge Characteristics

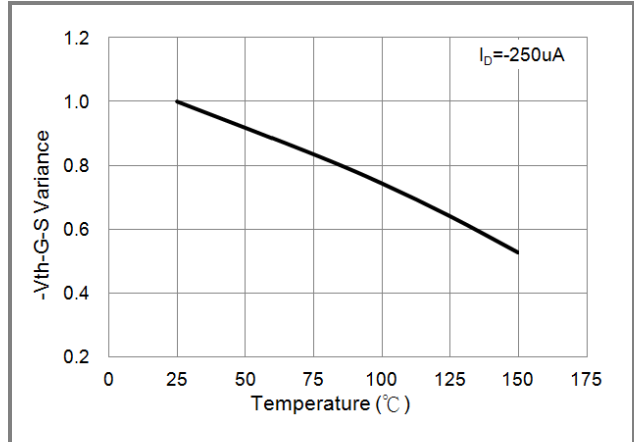

Fig.8 Threshold Voltage Variation with Temperature.

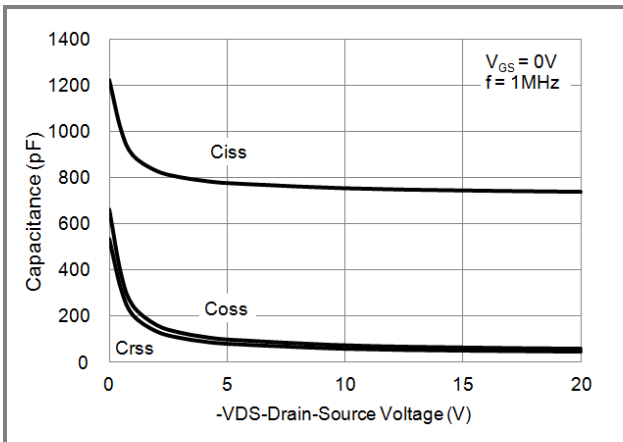

Fig.9 Capacitance vs. Drain-Source Voltage.



PJS6415

PART NO PACKING CODE VERSION

Part No Packing Code	Package Type	Packing type	Marking	Version
PJS6415_S1_00001	SOT-23 6L	3K pcs / 7" reel	S15	Halogen free
PJS6415_S2_00001	SOT-23 6L	10K pcs / 13" reel	S15	Halogen free

MOUNTING PAD LAYOUT

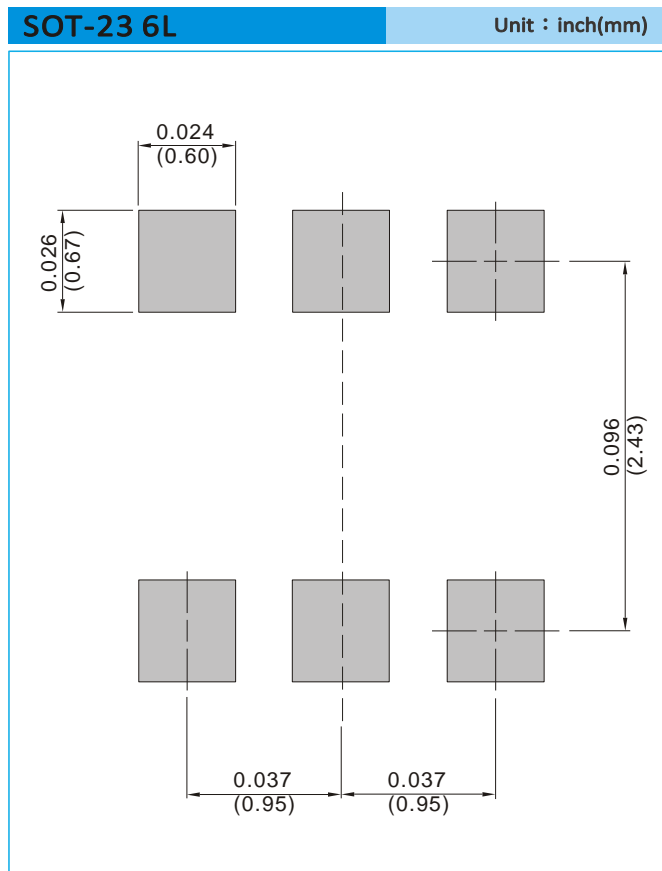



PJS6415

Disclaimer

- Reproducing and modifying information of the document is prohibited without permission from Panjit International Inc..
- Panjit International Inc. reserves the rights to make changes of the content herein the document anytime without notification. Please refer to our website for the latest document.
- Panjit International Inc. disclaims any and all liability arising out of the application or use of any product including damages incidentally and consequentially occurred.
- Panjit International Inc. does not assume any and all implied warranties, including warranties of fitness for particular purpose, non-infringement and merchantability.
- Applications shown on the herein document are examples of standard use and operation. Customers are responsible in comprehending the suitable use in particular applications. Panjit International Inc. makes no representation or warranty that such applications will be suitable for the specified use without further testing or modification.
- The products shown herein are not designed and authorized for equipments requiring high level of reliability or relating to human life and for any applications concerning life-saving or life-sustaining, such as medical instruments, transportation equipment, aerospace machinery et cetera. Customers using or selling these products for use in such applications do so at their own risk and agree to fully indemnify Panjit International Inc. for any damages resulting from such improper use or sale.
- Since Panjit uses lot number as the tracking base, please provide the lot number for tracking when complaining.